

1. Basic Diagnostics Procedure

A: BASIC PROCEDURES

1. GENERAL

The most important purpose of diagnostics is to determine which part is malfunctioning quickly, to save time and labor.

2. IDENTIFICATION OF TROUBLE SYMPTOM

Determine what the problem is based on symptom.

3. PROBABLE CAUSE OF TROUBLE

Look at the wiring diagram and check system's circuit. Then check the switch, relay, fuse, ground, etc.

4. LOCATION AND REPAIR OF TROUBLE

- 1) Using the diagnostics narrow down the causes.
- 2) If necessary, use a voltmeter, ohmmeter, etc.
- 3) Before replacing certain component parts (switch, relay, etc.), check the power supply, ground, for open wiring harness, poor connectors, etc. If no problems are encountered, check the component parts.

5. CONFIRMATION OF SYSTEM OPERATION

After repairing, ensure that the system operates properly.

B: BASIC INSPECTION

1. VOLTAGE MEASUREMENT

1) Using a voltmeter, connect the negative lead to a good ground point or negative battery terminal and the positive lead to the connector or component terminal.

2) Contact the positive probe of the voltmeter on connector (A).

The voltmeter will indicate a voltage.

3) Shift the positive probe to connector (B). The voltmeter will indicate no voltage.

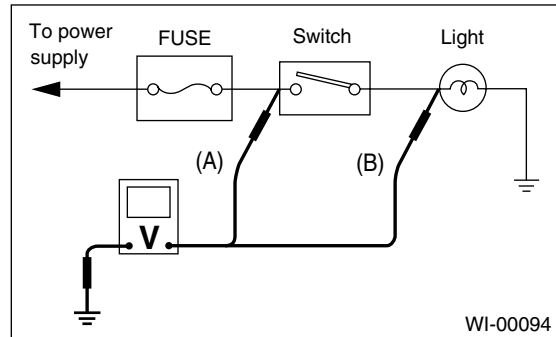

4) With test set-up held as it is, turn the switch ON. The voltmeter will indicate a voltage and, at the same time, the light will come on.

5) The circuit is in good order. If a problem such as a lamp failing to light occurs, use the procedures outlined above to track down malfunction.

BASIC DIAGNOSTICS PROCEDURE

WIRING SYSTEM

2. CIRCUIT CONTINUITY CHECKS

1) Disconnect the battery cable or connector so there is no voltage between check points.

Contact the two leads of an ohmmeter to each of the check points.

If the circuit has diodes, reverse the two leads and check again.

2) Use an ohmmeter to check for the diode continuity. When contacting the negative lead to diode positive side and positive lead to negative side, there should be continuity.

When contacting the two leads in reverse, there should be no continuity.

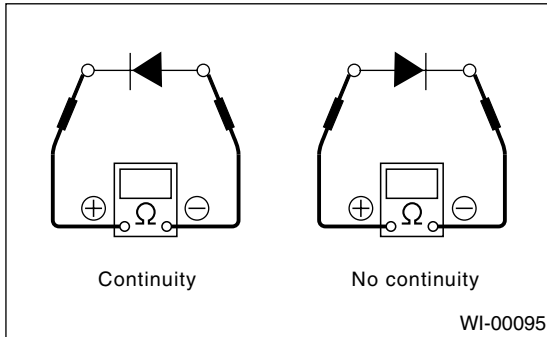

3) Symbol “○ — ○” indicates that continuity exists between two points or terminals. For example, when a switch position is “3”, continuity exists among terminals 1, 3 and 6, as shown in table below.

Terminal Switch Position	1	2	3	4	5	6
OFF						
1	○				○	○
2	○			○		○
3	○		○			○
4	○	○				○

WI-00096

3. HOW TO DETERMINE AN OPEN CIRCUIT

1) Voltmeter Method:

An open circuit is determined by measuring the voltage between respective connectors and ground using a voltmeter, starting with the connector closest to power supply. The power supply must be turned ON so that current flows in the circuit. If voltage is not present between a particular connector and previous connector is open.

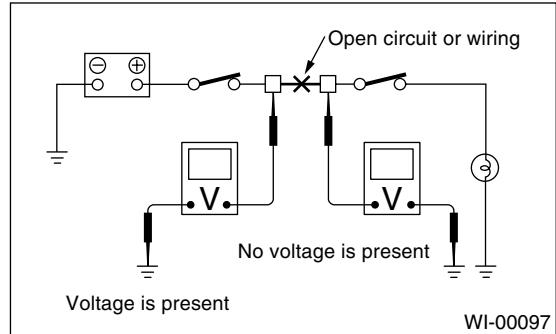

2) Ohmmeter method:

Disconnect all connectors affected, and check the continuity in wiring between adjacent connectors. When the ohmmeter indicates “infinite”, the wiring is open.

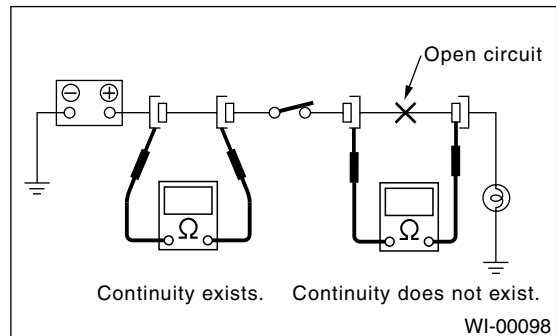

4. HOW TO DETERMINE A SHORT CIRCUIT

1) Test lamp method:

Connect a test lamp (rated at approx. 3 watts) in place of the blown fuse and allow current to flow through the circuit. Disconnect one connector at a time from the circuit, starting with the one located farthest from power supply. If the test lamp goes out when a connector is disconnected, the wiring between that connection and next connector (farther from the power supply) is shorted.

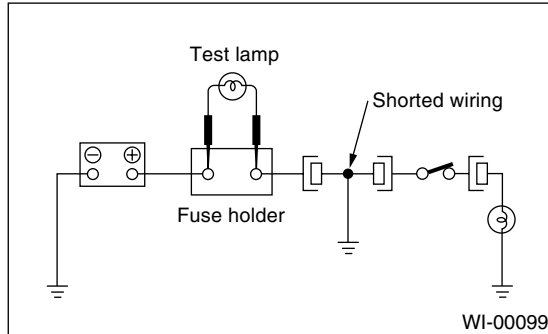

2) Ohmmeter method:

Disconnect all affected connectors, and check the continuity between each connector and ground. When the ohmmeter indicates continuity between a particular connector and ground, that the connector is shorted.

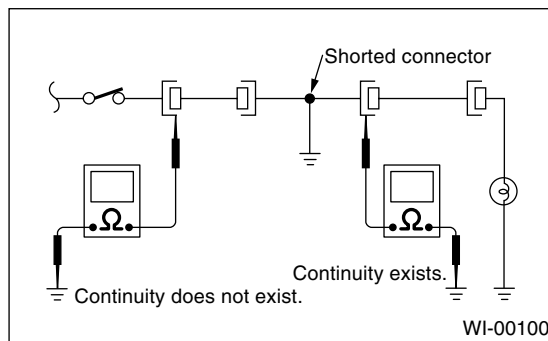

BASIC DIAGNOSTICS PROCEDURE

WIRING SYSTEM

C: HOW TO READ WIRING DIAGRAMS

1. WIRING DIAGRAM

The wiring diagram of each system is illustrated so that you can understand the path through which electric current flows from battery.

Sketches and codes are used in the diagrams. They should read as follows:

- Each connector and its terminal position are indicated by a sketch of the connector in a disconnected state which is viewed from front.

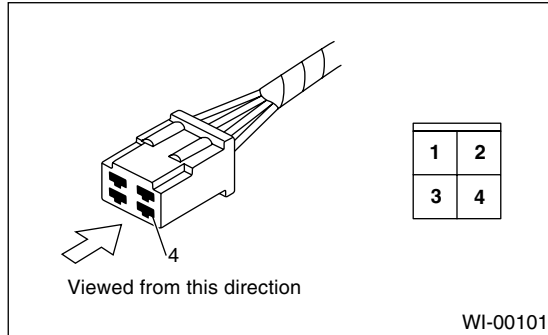

- The number of poles or pins, presence of a lock, and pin number of each terminal are indicated in the sketch of each connector. In the sketch, the highest pole number refers to the number of poles which connector has. For example, the sketch of connector shown in the figure indicates the connector has 9 poles.

Connector used in vehicle	Connector shown in wiring diagram		
	Sketch	Symbol	Number of poles
	<p>Double frames</p> <p>Indicates a lock is included.</p> <p>Indicates the number of poles.</p>		<p>Numbered in order from upper right to lower left.</p>
	<p>Indicates a lock is included.</p> <p>Single frame</p>		<p>Numbered in order from upper left to lower right</p>

WI-00102

BASIC DIAGNOSTICS PROCEDURE

WIRING SYSTEM

- When one set of connectors is viewed from the front side, the pole numbers of one connector are symmetrical to those of other. When these two connectors are connected as a unit, the poles which have the same number are joined.

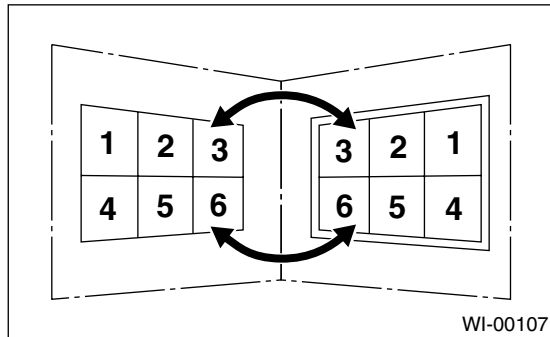

- Electrical wiring harness:**
The connectors are numbered along with the number of poles, external colors, and mating connections in accompanying list.
- The sketch of each connector in the wiring diagram usually shows (A) side of the connector. The relationship between wire color, terminal number and connector is described in figure.

NOTE:

A wire which runs in one direction from a connector terminal sometimes may have a different color from that which runs in the other direction from that terminal.

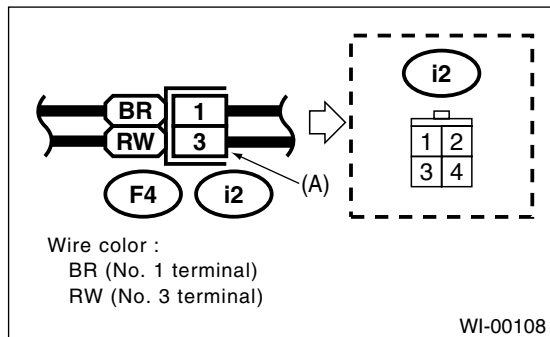

- In wiring diagram, connectors which have no terminal number refer to one-pole types. Sketches of these connectors are omitted intentionally.

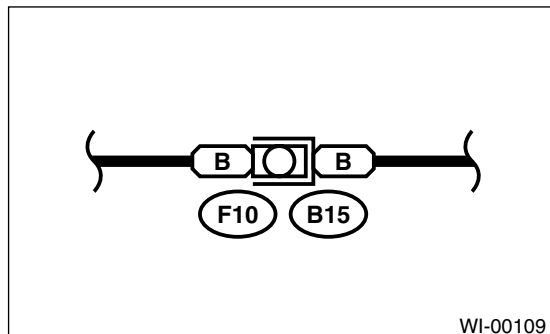

- The following color codes are used to indicate the colors of the wires used.

Color code	Color
L	Blue
B	Black
Y	Yellow
G	Green
R	Red
W	White
Br	Brown
Lg	Light green
Gr	Gray
P	Pink
Or	Orange
Lb	Light Blue
V	Violet
SA	Sealed (Inner)
SB	Sealed (Outer)

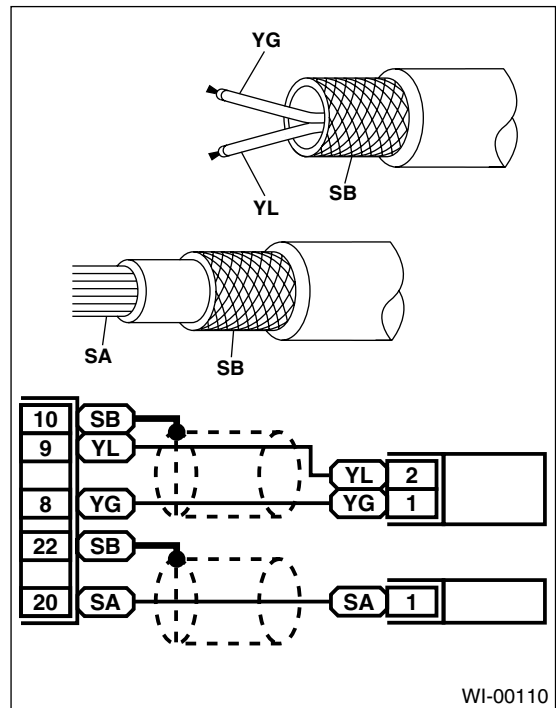

BASIC DIAGNOSTICS PROCEDURE

WIRING SYSTEM

- The wire color code, which consists of two letters (or three letters including Br or Lg), indicates the standard color (base color of the wire covering) by its first letter and stripe marking by its second letter.

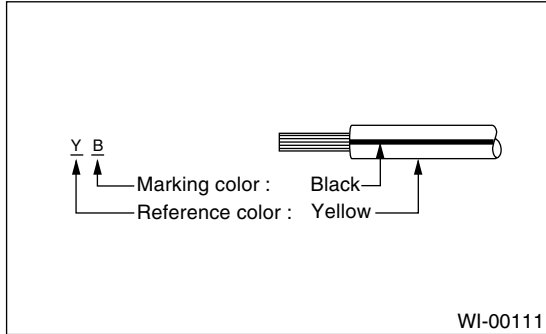

- The table lists the nominal sectional areas and allowable currents of wires.

CAUTION:

When replacing or repairing a wire, be sure to use the same size and type of wire which was originally used.

NOTE:

- The allowable current in the table indicates tolerable amperage of each wire at an ambient temperature of 40°C (104°F).
- The allowable current changes with ambient temperature. Also, it changes if a bundle of more than two wires is used.

Nominal sectional area mm ²	No. of strands/ strand diameter	Outside diameter of finished wiring mm	Allowable current Amps/ 40°C (104°F)
0.3	7/0.26	1.8	7
0.5	7/0.32	2.2 (or 2.0)	12
0.75	30/0.18	2.6 (or 2.4)	16
0.85	11/0.32	2.4 (or 2.2)	16
1.25	16/0.32	2.7 (or 2.5)	21
2	26/0.32	3.1 (or 2.9)	28
3	41/0.32	3.8 (or 3.6)	38
5	65/0.32	4.6 (or 4.4)	51
8	50/0.45	5.5	67

- Each unit is directly grounded to the body or indirectly grounds through a harness ground terminal. Different symbols are used in the wiring diagram to identify the two grounding systems.

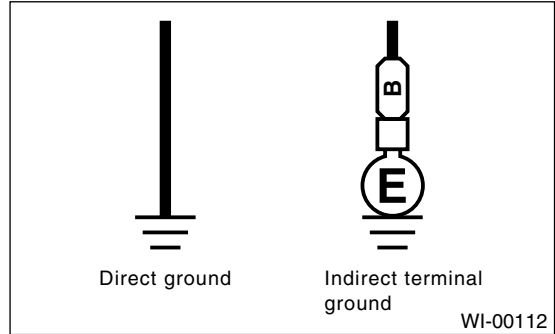

- The ground points shown in the wiring diagram refer to the following:

NOTE:

All wiring harnesses are provided with a ground point which should be securely connected.

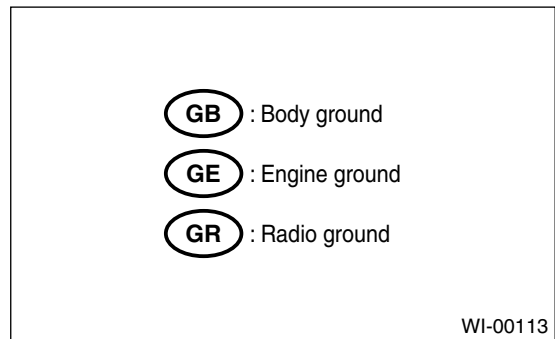

BASIC DIAGNOSTICS PROCEDURE

- Relays are classified as normally-open or normally-closed.
- The normally-closed relay has one or more contacts.
- The wiring diagram shows the relay mode when energizing circuit is OFF.

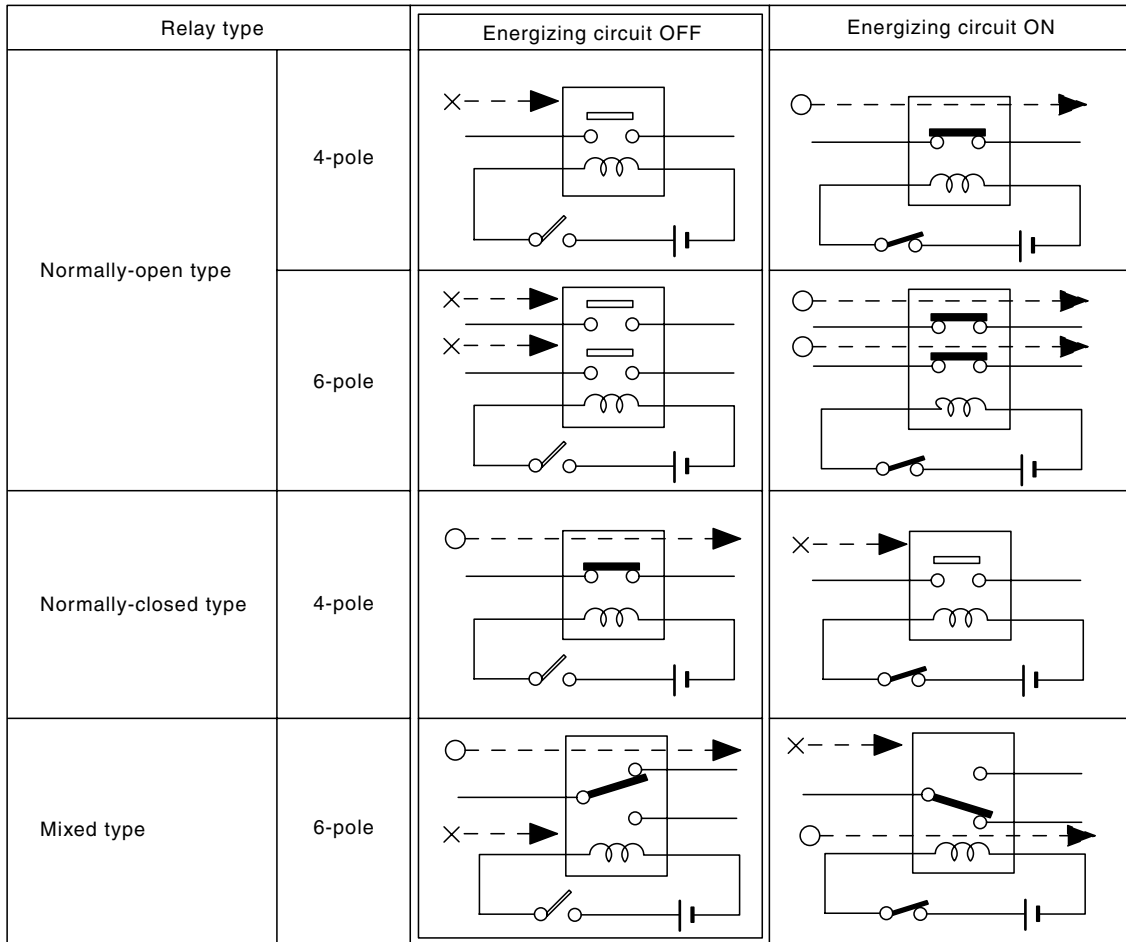

Key to symbols:

○ —▶ : Current flows.

× —▶ : Current does not flow.

BASIC DIAGNOSTICS PROCEDURE

WIRING SYSTEM

- Each connector number shown in the wiring diagram corresponds to that in wiring harness. The location of each connector in actual vehicle is determined by reading the first character of the connector (for example, a "F" for F8, "i" for i16, etc.) and type of wiring harness.

The first character of each connector number refers to the area or system of the vehicle.

Symbol	Wiring harness and cord
F	Front wiring harness
B	Bulkhead wiring harness
E	Engine wiring harness
T	Transmission cord, Rear oxygen sensor cord
D	Door cord LH & RH, Rear door cord LH & RH, Rear gate cord
i	Instrument panel wiring harness
R	Rear wiring harness, Fuel tank cord, Roof cord, Trunk lid cord
AB	Airbag wiring harness

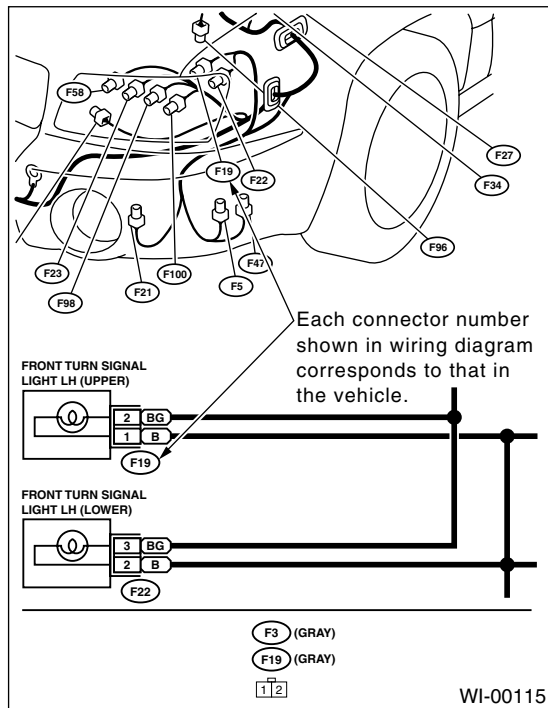

D: SYMBOLS IN WIRING DIAGRAMS

A number of symbols are used in each wiring diagram to easily identify parts or circuits.

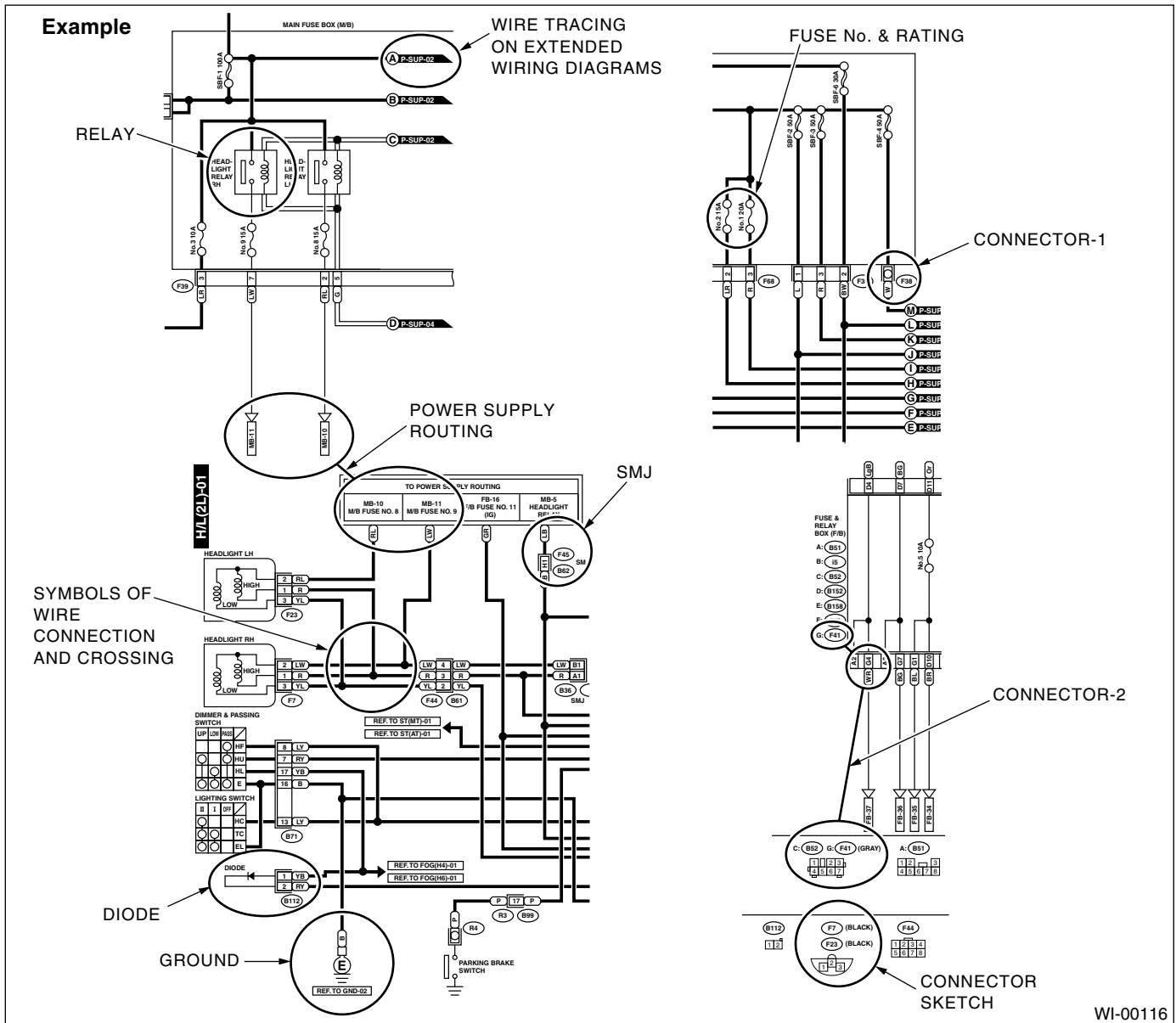

WI-00116

1. RELAY

A symbol used to indicate a relay.

2. CONNECTOR-1

The sketch of the connector indicates one-pole types.

3. WIRING CONNECTION

Some wiring diagrams are indicated in foldouts for convenience. Wiring destinations are indicated where necessary by corresponding symbols (as when two pages are needed for clear indication).

4. FUSE NO. & RATING

The "FUSE No. & RATING" corresponds with that used in fuse box (main fuse box, fuse and joint box).

5. CONNECTOR-2

- Each connector is indicated by a symbol.
- Each terminal number is indicated in the corresponding wiring diagram in an abbreviated form.
- For example, terminal number "G4" refers to No. 4 terminal of connector (G: F41) shown in the connector sketch.

BASIC DIAGNOSTICS PROCEDURE

WIRING SYSTEM

6. CONNECTOR SKETCH

- Each connector sketch clearly identifies the shape and color of a connector as well as terminal locations. Non-colored connectors are indicated in natural color.
- When more than two types of connector number are indicated in a connector sketch, it means that the same type connectors are used.

7. GROUND

Each grounding point can be located easily by referring to the corresponding wiring harness.

8. DIODE

A symbol is used to indicate a diode.

9. WIRE TRACING ON EXTENDED WIRING DIAGRAMS

For a wiring diagram extending over at least two pages, a symbol (consisting of the same characters with arrows), facilitates wire tracing from one page to the next.

A \longleftrightarrow A, B \longleftrightarrow B

10. SYMBOLS OF WIRE CONNECTION AND CROSSING

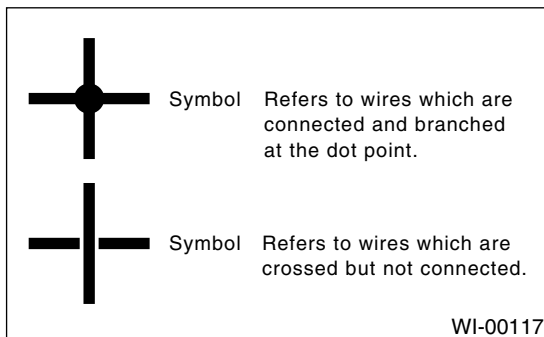

11. POWER SUPPLY ROUTING

A symbol is used to indicate the power supply in each wiring diagram.

“MB-5”, “MB-6”, etc., which are used as power-supply symbols throughout the text, correspond with those shown in POWER SUPPLY ROUTING in the wiring diagram.





Accordingly, using the POWER SUPPLY ROUTING and wiring diagrams permits service personnel to understand the entire electrical arrangement of a system.

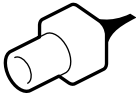
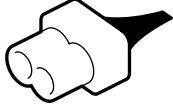
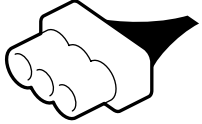

12. CLASSIFICATION BY SPECIFICATION

When the wiring diagrams differ according to vehicle specifications, the specification difference is described by using abbreviations.

E: CONNECTOR SYMBOL IN WIRING HARNESS

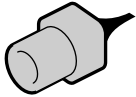
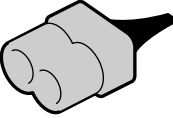
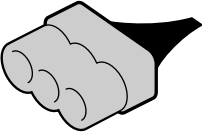
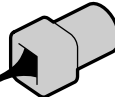
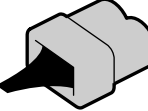
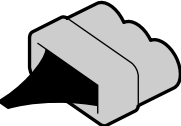
Main symbols of connector (in wiring harness) are indicated in below.

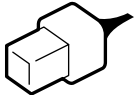
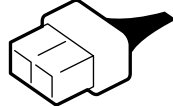
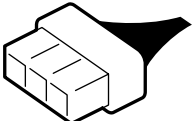
Water proof type	Female		
	Pole: From 1 to 8	Pole: From 9 to 20	Pole: More than 21
			
			
	Male		
			
			

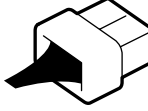
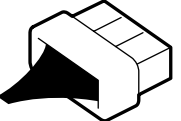
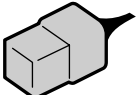
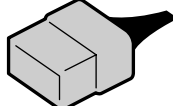
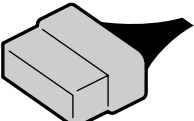
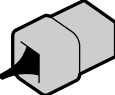
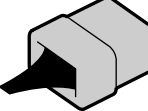
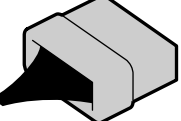
Standard type	Female		
	Pole: From 1 to 8	Pole: From 9 to 20	Pole: More than 21
			
			
	Male		
			
			

BASIC DIAGNOSTICS PROCEDURE

WIRING SYSTEM

F: ABBREVIATION IN WIRING DIAGRAMS

Abbreviation	Full name
ABS	Antilock Brake System
ACC	Accessory
A/C	Air Conditioning
AD	Auto Down
AT	Automatic Transmission
AU	Auto Up
+B	Battery
DN	Down
E	Ground
F/B	Fuse & Joint Box
FL1.5	Fusible link 1.5 mm ²
IG	Ignition
Illumi.	Illumination
LH	Left Hand
Lo	Low
M	Motor
M/B	Main Fuse Box
MG	Magnet
Mi	Middle
OP	Optional Parts
PASS	Passing
RH	Right Hand
SBF	Slow Blow Fuse
ST	Starter
SW	Switch
UP	Up
WASH	Washer